

TIPKALA - MB1/MB2

TIPKALA - MB1/MB2

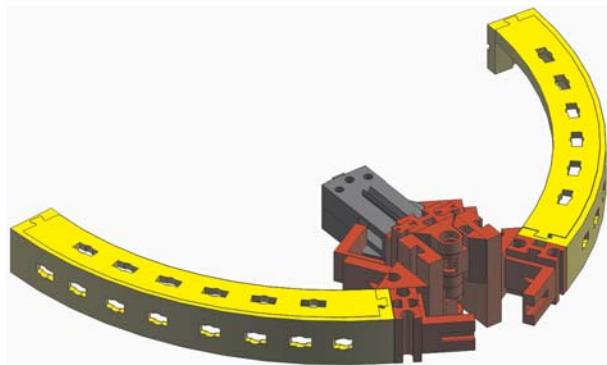

26



40000 Čakovec,
T. Goričanca 2
tel: 040/364-445
fax:040/364-230

WEB: <http://www.didakta.hr>
E-mail: didakta@ck.t-com.hr

fischertechnik 

26

TIPKALA MB1/MB2

ELEMENTI

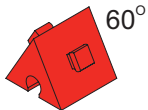
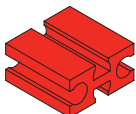
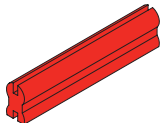
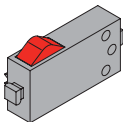
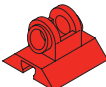
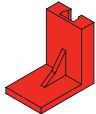
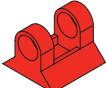
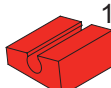
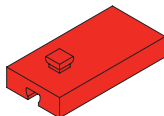
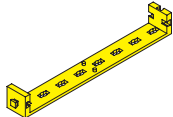
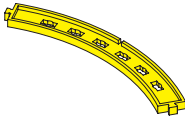
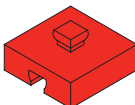
2	 60°	31010	4		37468
2		31061	2		37783
2		31426	6		38423
2		31436			
2	 15°	31981			
2		35049			
2		35054			
2		35055			
1		37237			

TIPKALA MB1/MB2

1

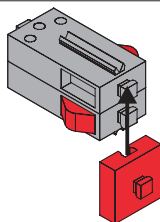
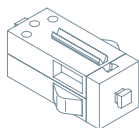

1

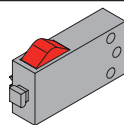

x 2 - 37783

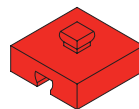

x 1 - 37237

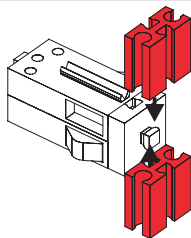
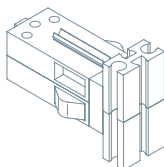

2

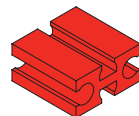

x 2 - 37468

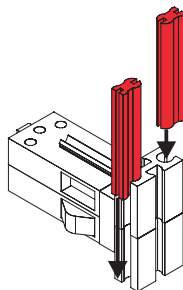
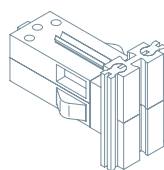

3

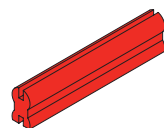

x 2 - 31061

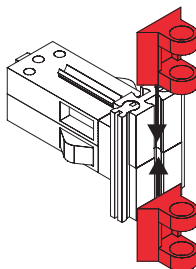
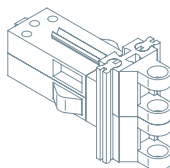

4

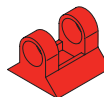

x 2 - 31436

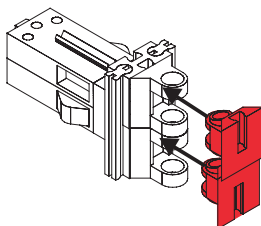
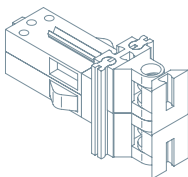

5



x 2 - 31426

TIPKALA MB1/MB2

2

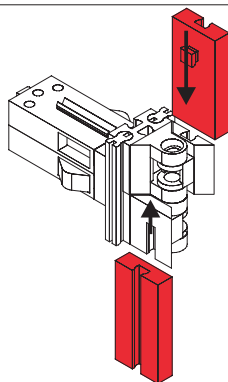
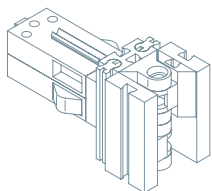

6

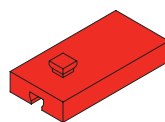

x 2 - 35049

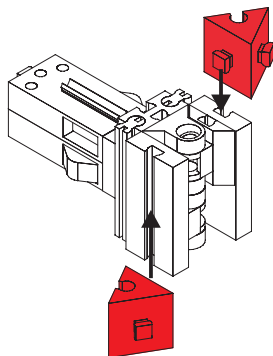
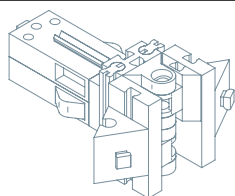

7

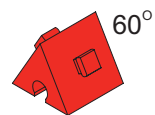

x 2 - 31010

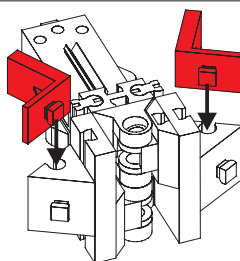
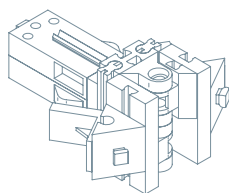

8



x 2 - 38423

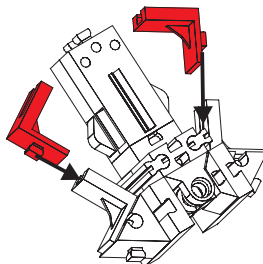
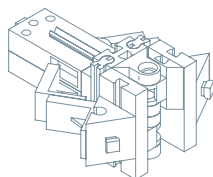

9



x 2 - 38423

TIPKALA MB1/MB2

3

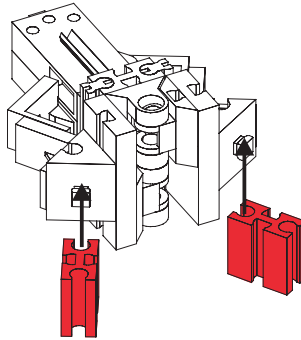
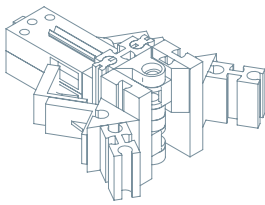

10

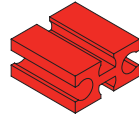

x 2 - 37468

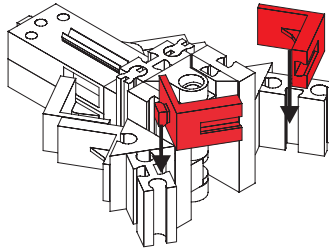
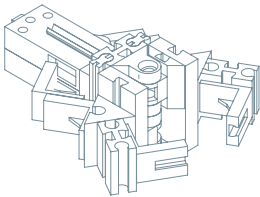

11

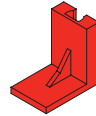

x 2 - 38423

12

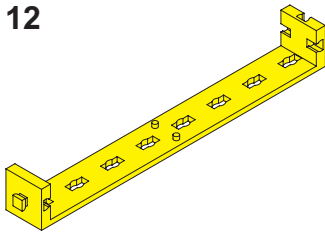

x 2 - 35054

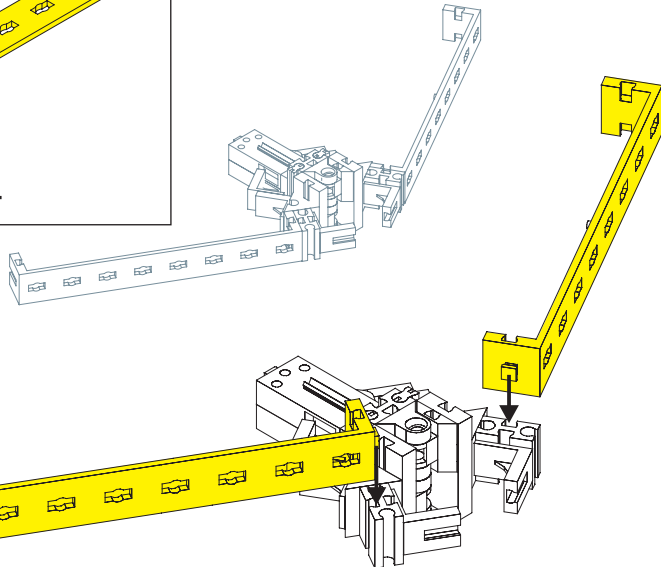

TIPKALA MB1/MB2

4

MODEL 1

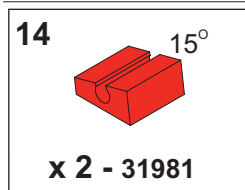
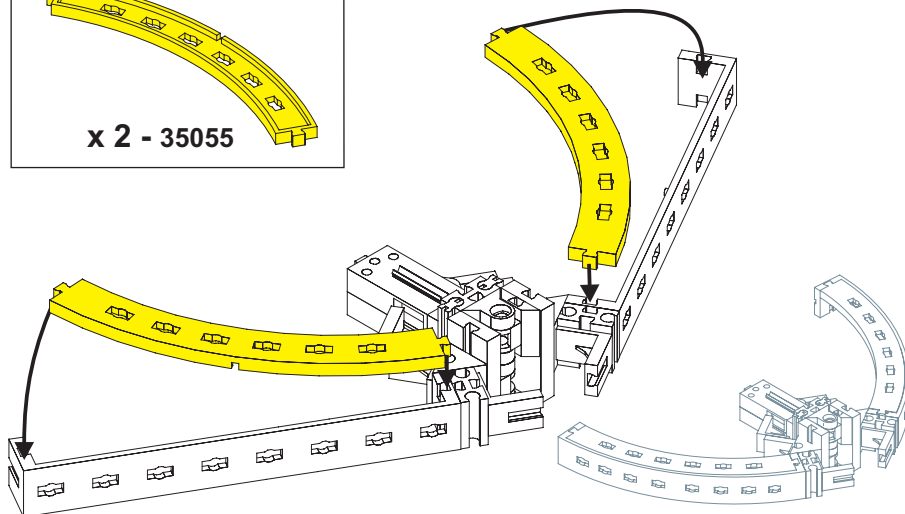
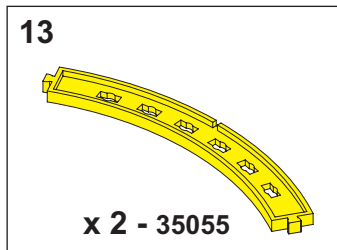

MODEL 2

