

FOTO SENZORI - MB1/MB2

ZA PARALELNO ULAZNO IZLAZNO SUČELJE
I FISCHERTECHNIK SUČELJE

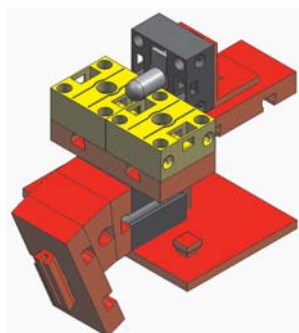

ZA PARALELNO SUČELJE **A**

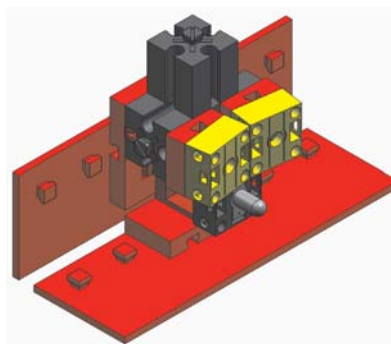

ZA FISCHERTECHNIK SUČELJE **B**



40000 Čakovec,
T. Goričanca 2
tel: 040/364-445
fax:040/364-230

WEB: <http://www.didakta.hr>
E-mail: didakta@ck.t-com.hr

fischertechnik 

FOTO SENZORI

ELEMENTI





1	 15°	31981	1		38251
3		31982	2		38423
2	 7,5°	32071	3		38428
1		32879			
1		32882			
2		36134			
1		37869			
1		38216			
2		38248			

FOTO SENZORI - model A

1

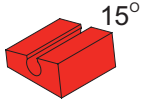
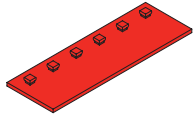
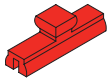

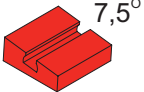
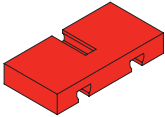
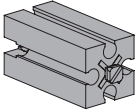
1

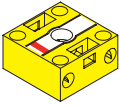
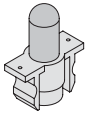
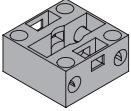
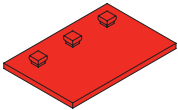
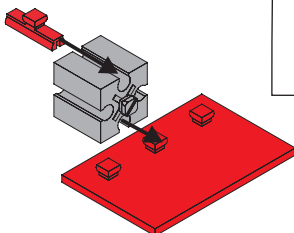
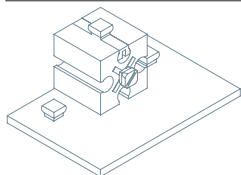
x 1 - 38248 x 1 - 32882
x 1 - 31982

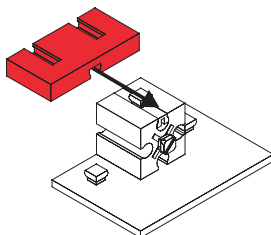
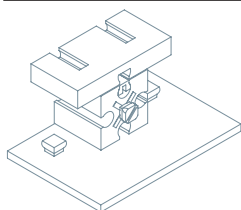

2

x 1 - 38428

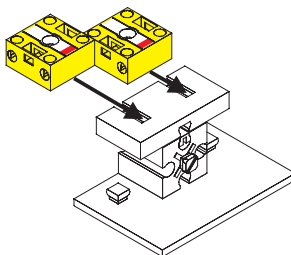
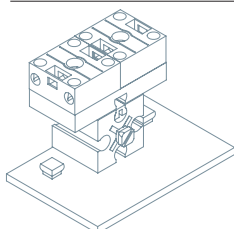

3

x 2 - 36134

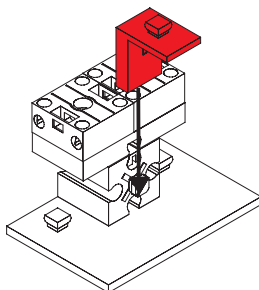
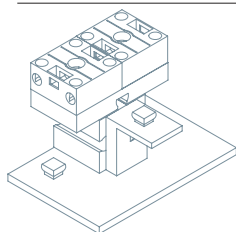

4

x 1 - 38423

FOTO SENZORI - model A

2

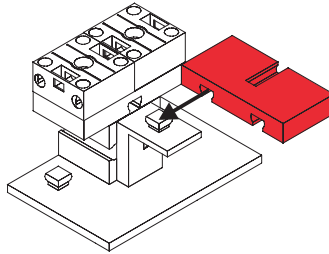
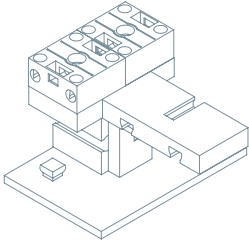

5

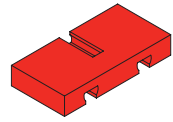

x 1 - 38428

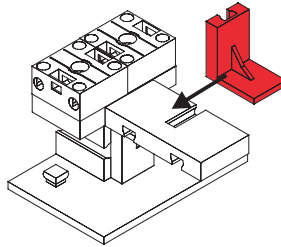
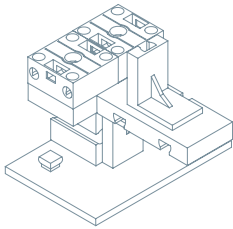

6

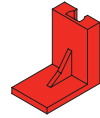

x 1 - 38423

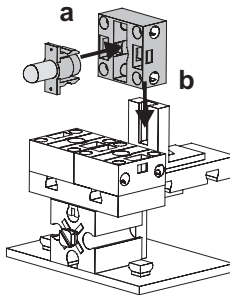
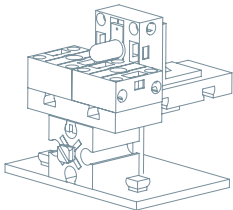

7

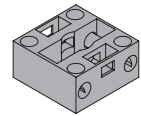

x 1 - 38216

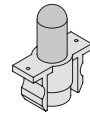

x 1 - 37869

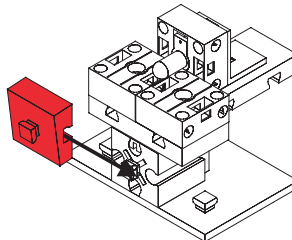
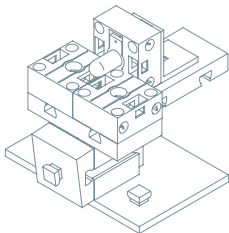

8

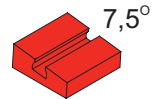

x 1 - 32071

FOTO SENZORI - model A

3

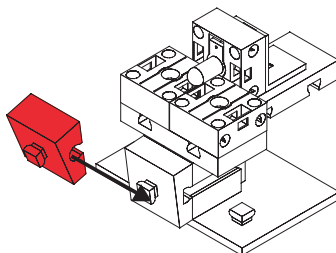
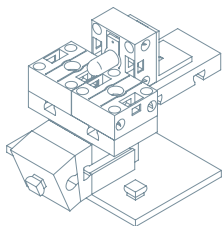

9

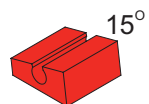

x 1 - 31981

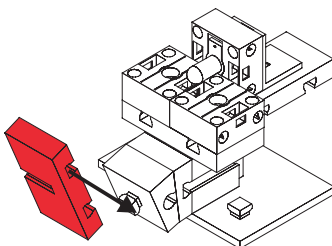
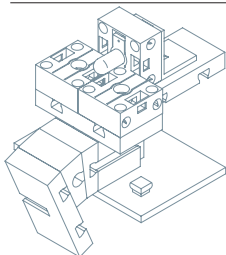

10

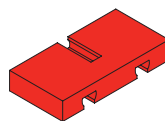

x 1 - 38428

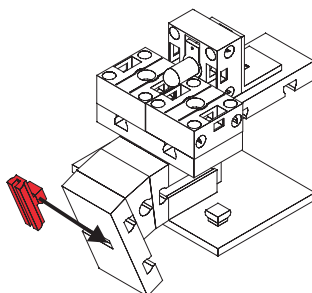
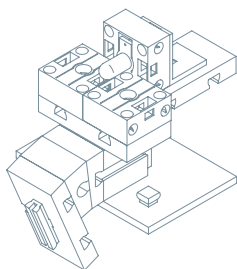

11

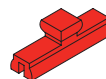

x 1 - 31982

FOTO SENZORI - model B

4

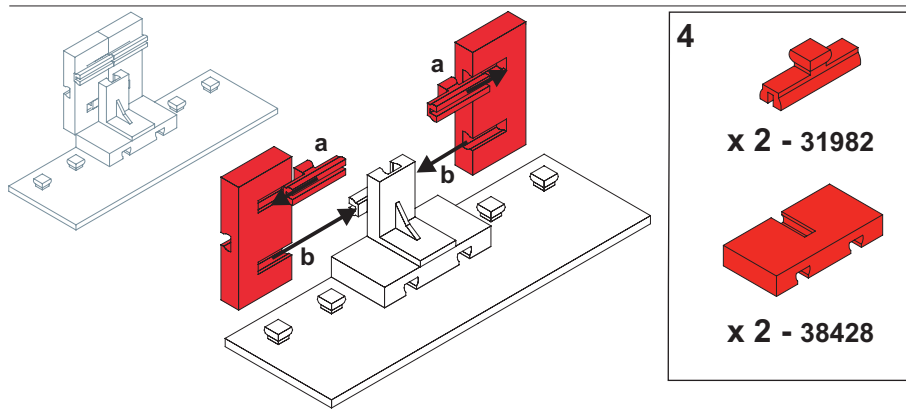
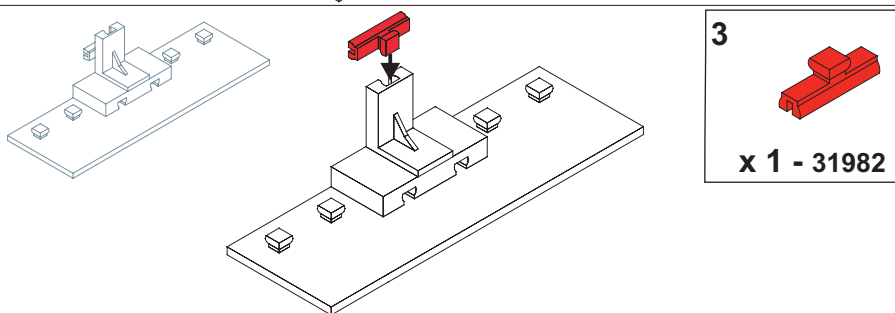
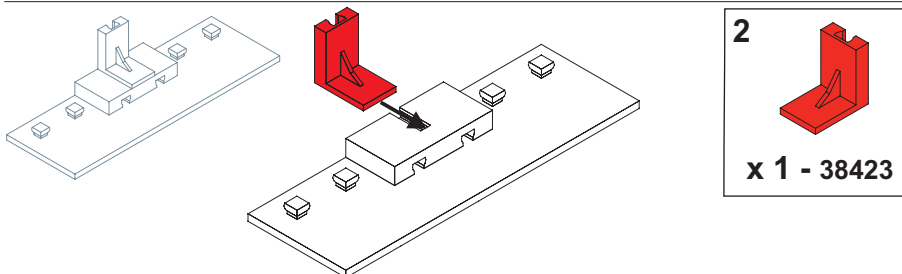
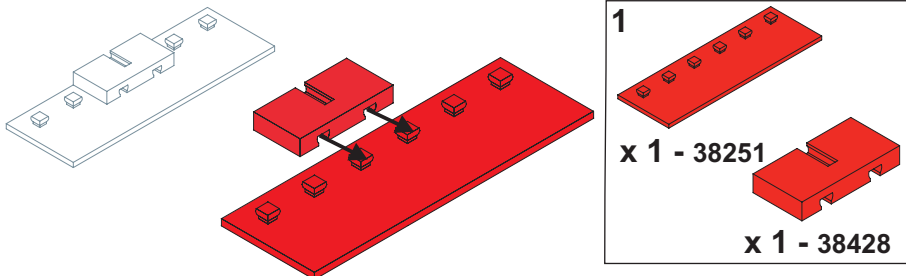

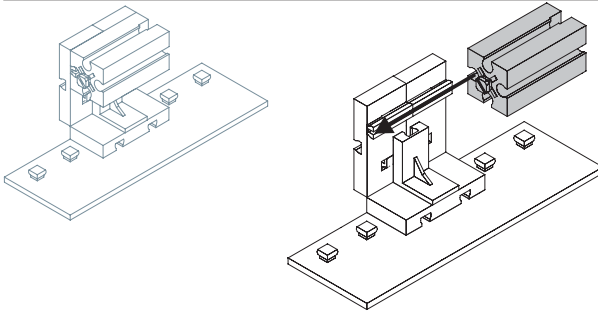

5

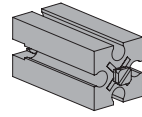

x 1 - 32879

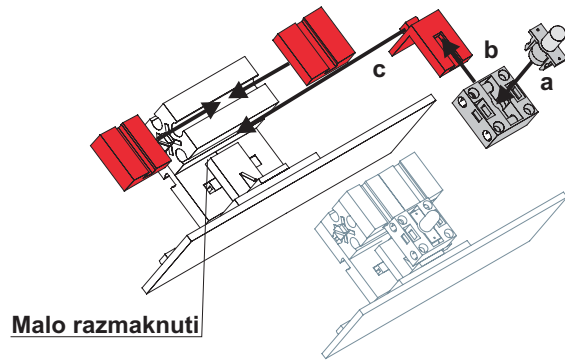

Malo razmaknuti

6

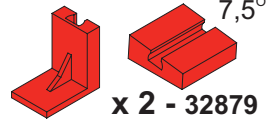

x 2 - 32879

x 1 - 38423

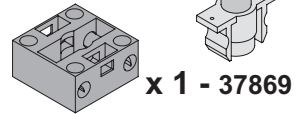

x 1 - 37869

x 1 - 38216

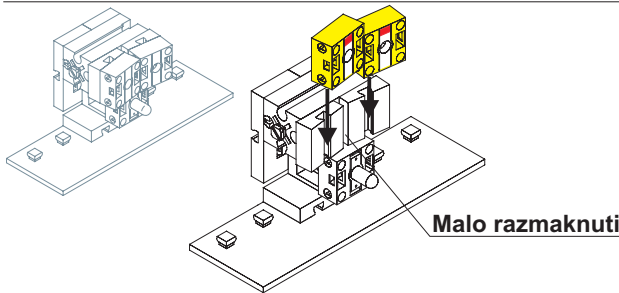

Malo razmaknuti

7

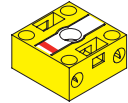

x 2 - 36134

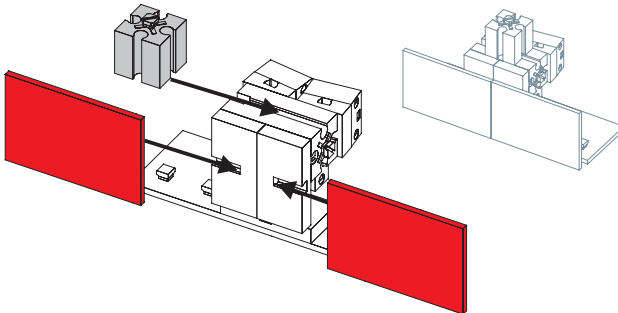

8

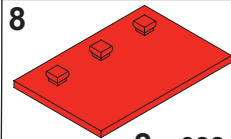

x 2 - 38248



x 1 - 32882