

FORMULA

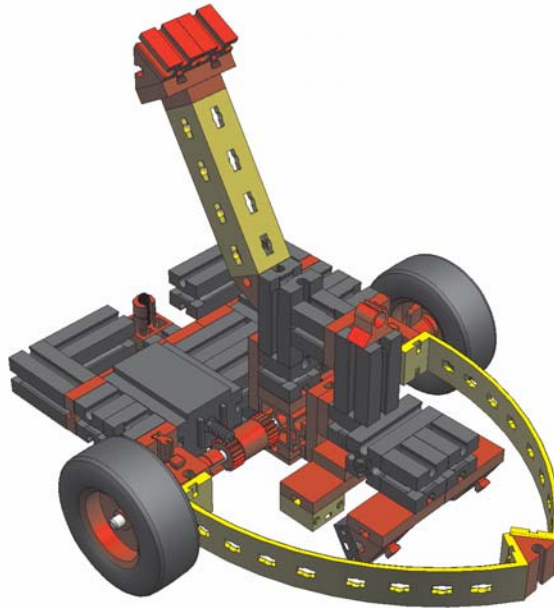

FORMULA



40000 Čakovec,
T. Goričanca 2
tel: 040/364-445
fax:040/364-230

WEB: <http://www.didakta.hr>
E-mail: didakta@ck.t-com.hr











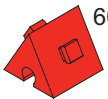

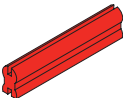
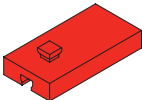
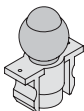
fischertechnik 

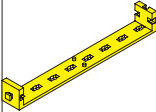
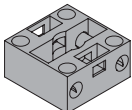
28

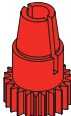
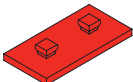
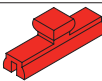
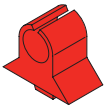
28

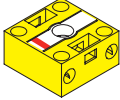
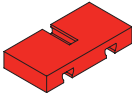
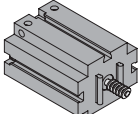
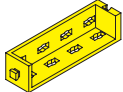
FORMULA

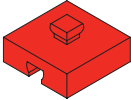
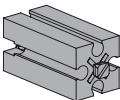
ELEMENTI

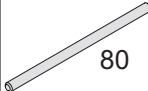
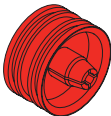
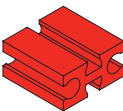
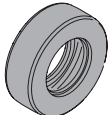
6	 60°	31010	2		35033	6		37679
3		31061	6		35049	2		37875
2		31597	2		35054	2		38216
2		31915	2		35113	2		38241
5		31982	1		35969	1		38246
4		32064	2		36134	2		38428
2		32293	1		36297			
1		32870	9		37237			
11		32879	4		37238			
11		32881	2		37384			
2		32883	3		37468			
2		32913						

FORMULA - SKLOPOVI

1

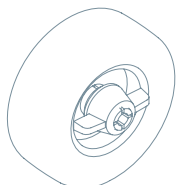

x 2 sklop 1

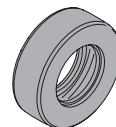
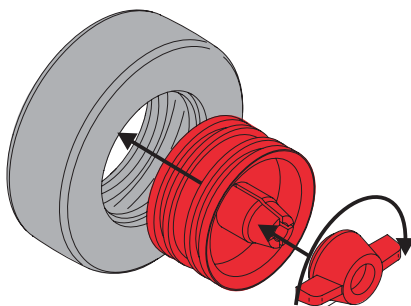

x 2 - 32913

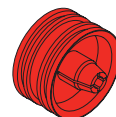

x 2 - 32883



x 2 - 35033

Maticu uvrnuti toliko da se drži, ne stegnuti

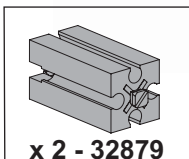
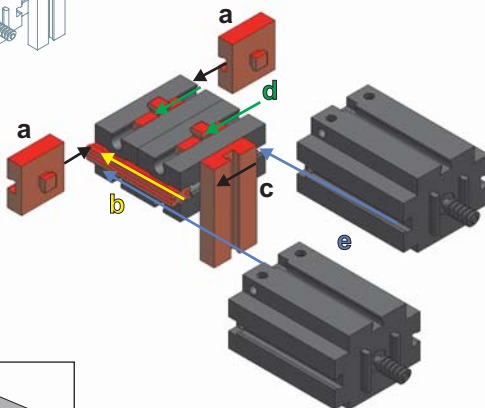
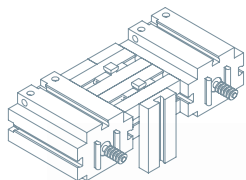

x 2 - 32879

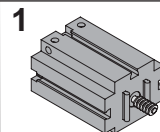

x 2 - 32293

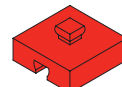

x 2 - 37237

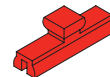

x 2 - 31982

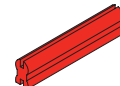

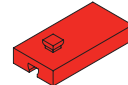

x 1 - 31061



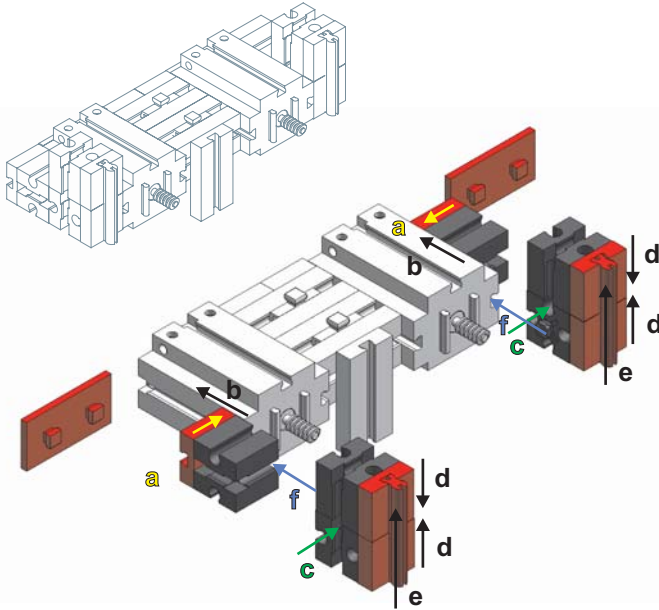

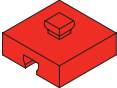
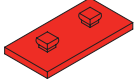

x 1 - 35049

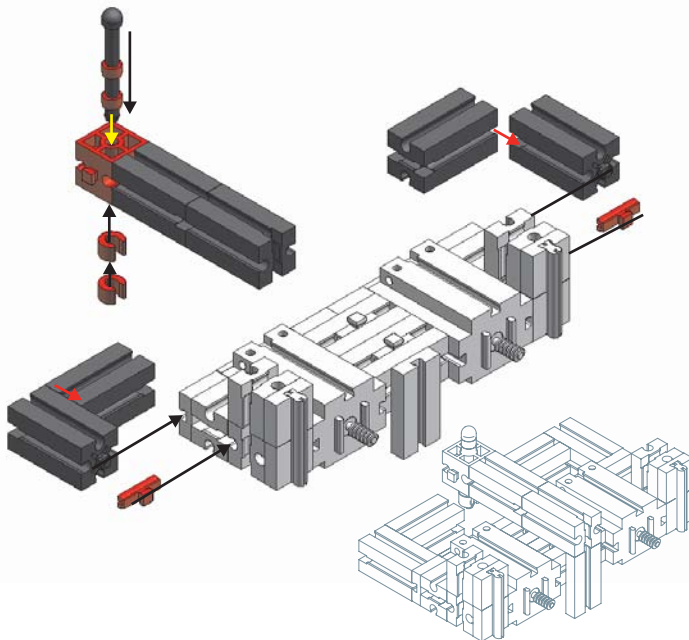

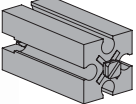

- 2**
-  x 6 - 32881
 -  x 6 - 37237
 -  x 2 - 38241
 -  x 2 - 31061

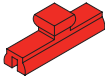

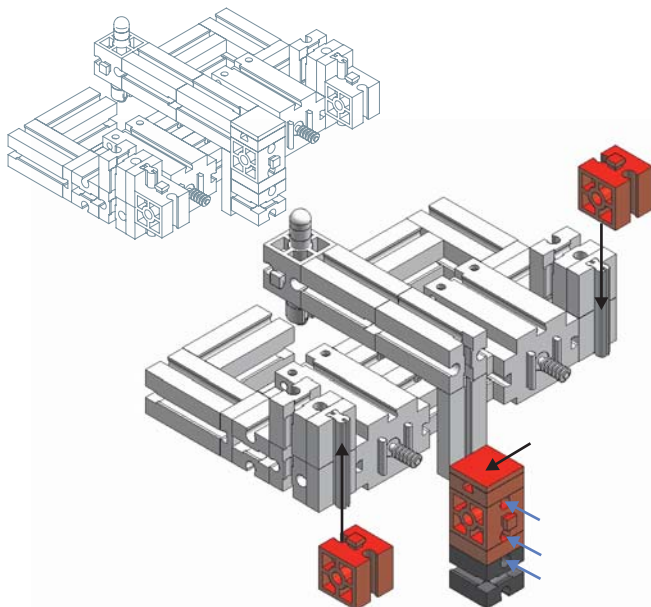

- 3**
-  x 6 - 32879
 -  x 2 - 37679
 -  x 1 - 32870
 -  x 1 - 32064
 -  x 2 - 31597
 -  x 2 - 31982

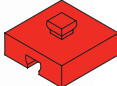
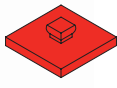

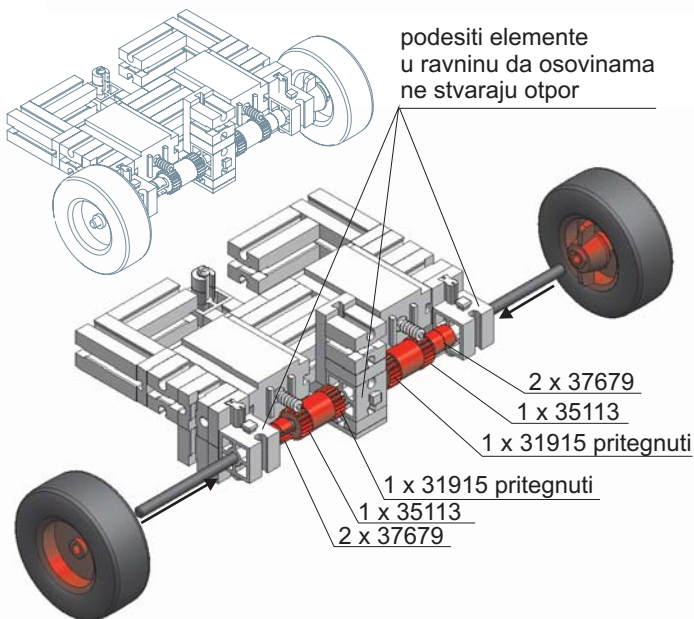
- 4**
-  x 3 - 32064
 -  x 1 - 32881
 -  x 1 - 37238
 -  x 1 - 37237
 -  x 1 - 38246

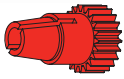

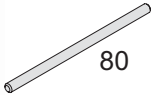
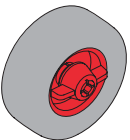

- 5**
-  x 2 - 35113
 -  x 4 - 37679
 -  x 2 - 31915
 -  80
x 2 - 37384
 -  x 2 - sklop 1

80

FORMULA

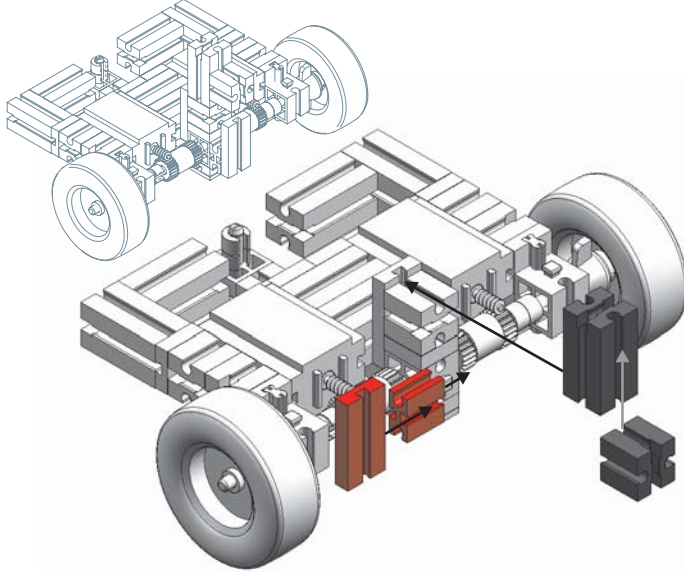

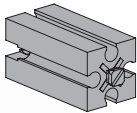
4

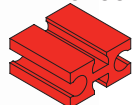
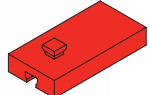

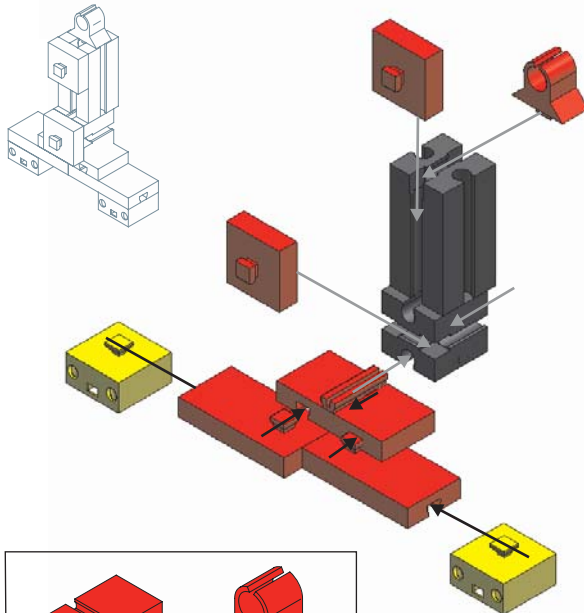
- 6**
-  x 1 - 32879
 -  x 1 - 32881
 -  x 1 - 37468
 -  x 1 - 35049

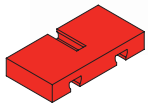
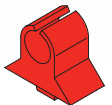

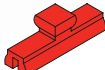
-  x 1 - 38428
-  x 1 - 35969

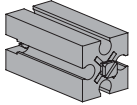
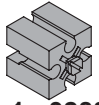
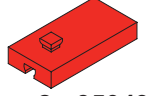
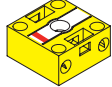
- 7**
-  x 1 - 31982
 -  x 2 - 37238
 -  x 1 - 32879
 -  x 1 - 32881
 -  x 2 - 35049
 -  x 2 - 36134

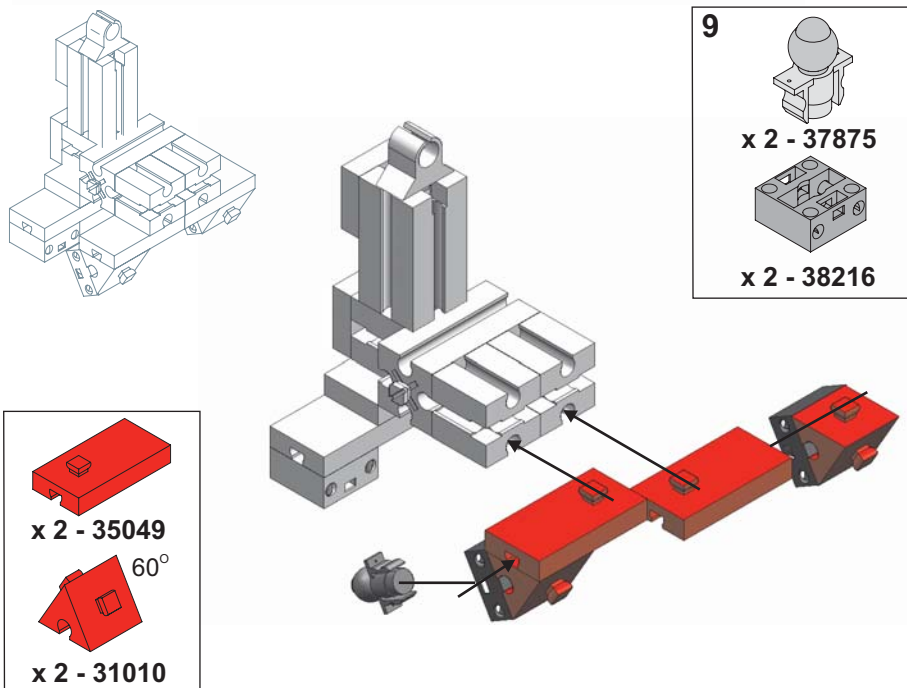
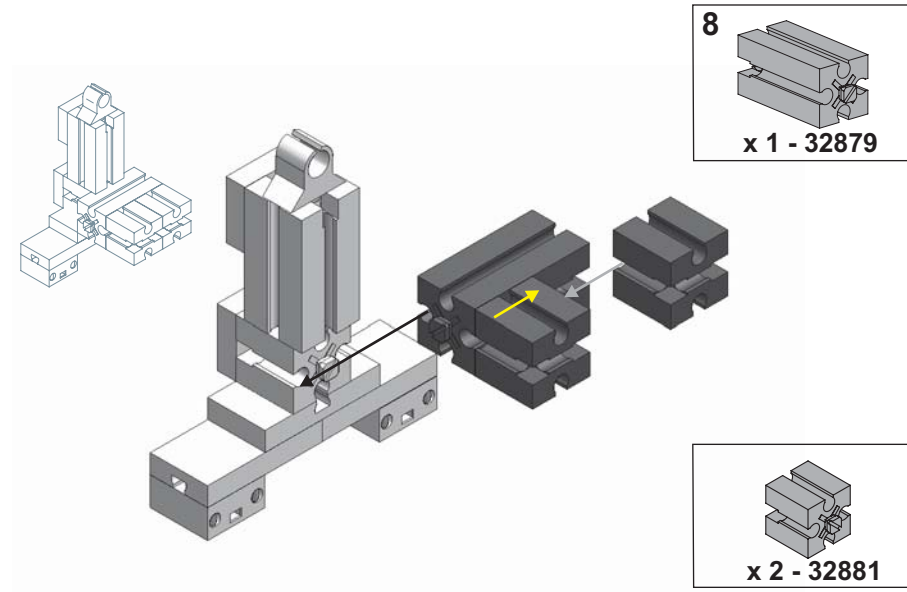

FORMULA

6

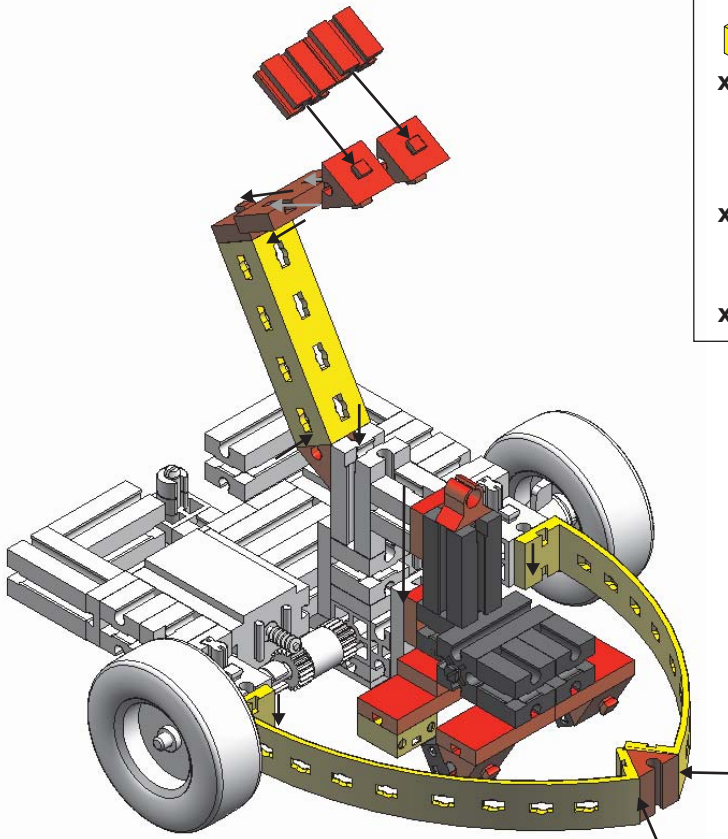
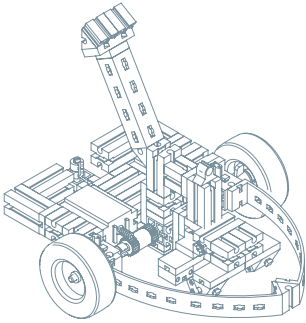

10

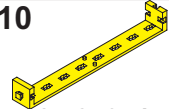

x 2 - 35054

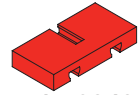

x 1 - 38428

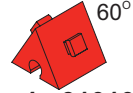

x 4 - 31010

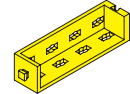

x 1 - 36297

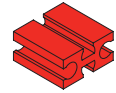

x 2 - 37468



x 1 - 37238